

**INSTALLATION AND
OPERATING INSTRUCTIONS
FOR
NATURE'S COMFORT
WOOD HOT WATER
OPEN SYSTEM BOILER
(NON-PRESURIZED)
2009-2011
NCB-325G**

**Manufactured by
Nature's Comfort LLC.
Made in the USA**

www.naturescomfortllc.com



**BUILT LIKE A TANK
WITH LASER PRECISION**

Revision 2010-1.0

INTRODUCTION

Thank you and congratulations on the purchase of your new Nature's Comfort Boiler!

With the purchase of this Nature's Comfort boiler, you can now appreciate the high degree of craftsmanship and reliability that are a result of every boiler being carefully hand-built. Your choice shows the recognition you have for high quality products.

We deem it important to provide you with this operation and maintenance manual, allowing you to use your equipment under the best possible conditions and in the most optimal manner and furthermore to increase it's operating life. **Read through carefully before beginning installation, follow all instructions and keep this manual handy.**

THIS MANUAL INCLUDES IMPORTANT SAFETY INFORMATION ON PAGE 5

Again, thank you for purchasing a Nature's Comfort Boiler.

We appreciate your business!

For the most up to date installation and operation information, or if you need to see any page in color, go to www.naturescomfortllc.com.

Please keep this manual with all other important papers. The information in this manual is necessary for the installation, operation and proper use of your boiler. If you should ever have a problem or question refer to this manual or call your dealer. Please have your serial number ready. This is found on a label on the back of the rear access door or stamped into the fire door jamb on the top left. If your dealer does not have the information you need, request they contact Nature's Comfort and your dealer will be further educated to provide the best possible customer service. If you are unable to get service from or reach your dealer you may contact Nature's Comfort via email: warranty1@naturescomfortllc.com. If you do not have email you may call 877-251-7740. Please keep in mind that Nature's Comfort built your boiler but did not install it and has no control over the installation, the efficiency of the building's insulation or what is burned in the boiler.

Table of Contents

I. General Information

A. Terminology.....	4	E. Safety Precautions.....	5
B. Specifications.....	4	F. 20 Year Limited Warranty, Treatment.....	6
C. Clearance to Combustibles.....	4	G. Customer Warranty Card.....	7
D. Boiler Dimensions.....	4		

II. Best Outdoor Boiler Burn Practices

A. Fuel Used.....	8	G. Heating Domestic Hot Water.....	10
B. Loading Fuel.....	8	H. Thermostat, Boiler Controls.....	10
C. Starting a Fire.....	8	I. Controls & Pex Pipe Connections.....	11
D. Location.....	8	J. Power Loss Procedure.....	11
E. Wood Recommendations.....	9	K. Insulated Pex Pipe.....	11
F. Heating the Home.....	9		

III. Installing the Boiler

A. Location of Boiler.....	12	H. Adding Bypass Valves.....	15
B. Concrete Block Footing.....	13	I. Installing Heat Exchanger In Plenum.....	15
C. Plumbing Hookup.....	13	J. Installing Heat Exchanger In Small Plenum.....	17
D. Wiring the Boiler.....	14	K. Bleeding the Heat Exchanger.....	18
E. Installation of Pex Pipe.....	14	L. Air Flow through Plenum.....	18
F. Filling Boiler with Water.....	14	M. Thermostat Wire Layout.....	18
G. Plumbing Parts Needed.....	14		

IV. Other Hook Ups - Heating Domestic Water, Pools and Spa's

A. Layout of Water Lines for a Sidearm Heat Exchanger.....	19
B. Warm Weather Operation and Hot Water Bypass.....	19
C. Heating a Pool or Spa.....	20
D. Hooking Up the Outdoor Boiler To An Existing Boiler.....	20

V. Maintenance

A. Cleaning Out Ash.....	21
B. Creosote.....	21
C. Door Seals.....	21
D. End of Season.....	21

VI. Trouble Shooting..... 22

VII. Disclaimer

B. Going Away.....	23
--------------------	----

Parts List.....	24
-----------------	----

Mail in Warranty Card.....	25
----------------------------	----

I. General Information

A. Terminology In This Manual

- a. Boiler:** Refers to the Nature's Comfort boiler you purchased.
- b. Furnace:** Refers to an indoor gas or oil fired unit which heats the air for your home. This would be your existing furnace.

B. Specifications

Type of fuel: Seasoned Hardwood Cordwood only.
Location: Outdoor use only.
Electrical Rating: 115 VAC, 5A (15A max when convenience outlets used), 60 HZ
Min. Circuit Breaker: 15 Amps.
Draft Blower: 270 CFM max, 115 VAC
Water Pump: 115 VAC, 2A max.

C. Clearance to Combustibles Required

Top, Front, Rear and Sides: 36 inches
Flooring: Non-Combustible
Chimney: 36 inches

D. Boiler Dimensions & Specifications

NCB-325G 460,000 BTU, 325-gallon water tank, 10,000 sq ft.*
46 1/2" x 85" x 92" tall, 2115 pounds

*Will heat up to (x)sq ft (This must include all heated areas of home as well as basement.) with proper installation, properly insulated building and when properly seasoned hardwood is used (20% moisture content). Deduct a minimum of 500 sq ft if heating domestic hot water.

Firebox Info:

Cubic Feet	Description	Width	Depth	Opening	Ash Pan
28.5cu/ft	oval	30"Wx36"H	54"	27"W x 25.5"H	39" X 11.75"X 4"

Steel Thickness:

Water Jacket	Firebox
7ga. (approx. 3/16")	¼"

E. Safety Precautions

Do not operate this equipment for anything other than its intended purpose or for anything other than in accordance with the instructions contained in this manual and all other instructions accompanying the boiler. It is important to observe safety precautions to protect yourself and others from possible injury. Observe all safety stickers on the boiler.

A qualified electrician must wire this boiler in accordance with the National Electrical Code.

1. Never use any type of petroleum based product, charcoal starter, lighter fluid, lantern fuel, kerosene or any other flammable accelerant to start the fire in the firebox of your boiler. Keep all such liquids well away from firebox.
2. If using antifreeze, use only non-toxic, follow manufacturer's recommendations on mixing ratio and test annually per manufacturer's specs. Keep containers of antifreeze, which is flammable, well away from the boiler.
3. The use of treated wood (painted, treated, etc.) and any other salvaged material that can emit toxic gases into the environment and is corrosive towards the components of the appliance is not allowed and voids your warranty.
4. DANGER! Risk of fire or explosion - Do not burn garbage, gasoline, naphtha, engine or drain oil, other flammable liquids or inappropriate materials, household or yard waste as burning these materials can reduce the life of the boiler, will void your warranty and is illegal in most areas.
5. When opening the fire box door, pause momentarily between the first latch and the safety latch to allow any combustion gases to burn off. Always close the firebox door securely.
6. In the event of a runaway fire, make sure the loading door and ash pan are tightly shut, unplug the control power, make sure the blower cover is seated and keep the water jacket full.
7. WARNING! Risk of fire – Do not operate with flue draft exceeding 0.1000" W.C. Drill a hole in the chimney near the peak of the roof for a place to measure and contact an HVAC professional for this if needed. Do not operate with ash pan or fuel loading door open. Do not store fuel or other combustible material within the marked installation clearances. Inspect and clean chimney regularly. Check to be sure the ash pan is fully inserted. Leaving a small crack or opening can cause over-heating in the firebox, boiling the water off, damage of the unit and voiding the warranty.
8. CAUTION! Hot surfaces. Keep children away. Do not touch during operation. Always use proper care when installing, operating and maintaining the boiler.
9. Always wear protective gloves and glasses and be aware that hanging and loose clothing can catch fire.
10. Do not modify the boiler. Do not connect this unit to a chimney flue serving another appliance.
11. Failure to heed these warning or any additional warnings on the boiler may result in an accident causing personal injury and damage and void the warranty.

CALL YOUR LOCAL MISS DIG HOTLINE BEFORE YOU DIG TRENCHES!

Disposal of Ashes:

Caution! Ash pan is hot! Turn blower off before removing! Wear safety glasses and use heavy gloves to pull out ash pan drawer to remove ashes. The ashes and nothing else should be placed in a metal container with a tight fitting lid. The closed container should be placed on the ground or a non-combustible floor well away from all combustible materials. Once cool, the ashes may be disposed of.

All installation and operation must follow Federal, Provincial, State and Local Codes

F. 20 Year Limited Warranty

Nature's Comfort LLC, of Shipshewana, IN 46565 warrants material and labor on any defects in workmanship on the firebox for a period of 20 years from the purchase date to the original owner only (see proration below). If there is a leak in your properly delivered, installed and maintained Nature's Comfort boiler, we will repair for the first 5 years at no cost and prorated after that (see below). The water jacket is warranted for a period of 10 years from the purchase date to the original owner only (see proration below). Repair can be denied if the unit's water jacket has exceeded 220 degrees.

This warranty is limited to defective parts and excludes any incidental and consequential damages connected therewith. Nature's Comfort does not warranty damage or malfunction to a unit caused by ash corrosion or allowing the unit to overheat. The fire drum must be completely cleaned out of all ashes and creosote a minimum of 2 times per year, half way through the heating season and at the end of heating season. The chimney must be covered when the boiler is not in use. Caulk around chimney and float stack must be inspected monthly and re-sealed if necessary. Caulk sealant and rope gaskets are not covered under this warranty. Damage caused by abuse, neglect, accidents, improper installation, customer or dealer modification, overheating and/or freezing will not be covered under warranty. Damage caused by burning flammable materials (i.e. petroleum products) will not be covered under warranty. Nature's Comfort does not warranty boilers against environmental conditions out of its control. Nature's Comfort does not warranty or guarantee against your area's governing laws or changes in your area's governing laws that will affect the use or nonuse of the unit.

Nature's Comfort is not responsible for replacement of water, water treatment, antifreeze and glycol, costs of transportation or shipping charges. On sight non-warranty parts and labor will be provided at the discretion of your dealer. Please contact your dealer for their current non-warranty rates. Labor for repairing or replacing parts under warranty will be covered by your dealer.

Nature's Comfort's wood boilers are not meant to be your sole source of heat. It is the responsibility of the owner to have a backup system in place. If you do not have a backup source of heat you are at risk of damage due to lack of heat. Nature's Comfort will not warranty or be responsible for any damage caused by lack of heat at your premises or for any cost incurred from using a backup heat system in the event of a boiler failure.

There is no written or implied performance warranty on the boiler as Nature's Comfort has no control over the installation, structure insulation, maintenance, daily operation and heating demand on a unit or what is burned in the boiler. Nature's Comfort will not cover or be held responsible for any cost of wood or coal burned in excess of what is expected or considered normal as installation and structure size and insulation conditions are out of its control.

Treatment & Testing

If not using anti-freeze, your boiler must have "Nature's Comfort Boiler treatment" added during initial filling with water and must be tested annually at the end of a heating season to ensure proper concentration (500ppm minimum of Nitrite) for your warranty to remain valid. Initial mix ratio for each boiler is: NCB120 – 1.5Qts; NCB175 – 1.5Qt; NCB250 – 2Qts; NCB325G – 3Qts. There is no maximum limit. Contact Nature's Comfort or your dealer to obtain water treatment. You may have your water tested by your dealer or send a minimum 4oz. water sample with your name, address, phone number, email address, dealer name, date sample was taken, model and serial number to: Nature's Comfort LLC , PO Box 949 Shipshewana, IN 46565. Results will be sent to you and you must keep on file to show proof of treatment and testing if warranty work is ever needed. Testing done by customer will not be accepted for warranty claims but is encouraged for monitoring treatment levels to obtain the maximum life out of a Nature's Comfort boiler particularly if water is being added throughout a heating season. Replace water & treatment if inspection shows water is not clear.

Nature's Comfort On-Site Warranty Proration:

Nature's Comfort will pay costs of warranty work based on the following proration:

Firebox: Years 1 - 5: 100%, Year 6 - 90%, Year 7 - 80%, Year 8 - 70%, Year 9 - 60%, Year 10 - 50%, Year 11 - 40%, Year's 12 – 14: 30%, Years 15-20: 20%

Water Jacket: Years 1 - 5: 100% Year 6 - 80%, Year 7- 60%, Year 8 - 40%, Year 9 - 20%, Year 10 - 10%

1 Year Warranty on Other Components

Nature's Comfort warranties, to the original owner only, any component a part of the boiler that is defective during normal usage for a period of 1 year. Shipping for returning defective parts is not included. Replacement parts are obtained from the dealer purchase was made through. After one year, your dealer may charge you for any parts provided or work performed. If you choose to perform the labor of replacing a part covered under warranty yourself, your dealer may request credit card information and send you the replacement part. If you do not return the defective part within 10 days your credit card will be charged for the replacement part.

Warranty Procedure

All claims under this warranty must be made through the dealer where the boiler was purchased. If an inspection by the dealer indicates that a warranty claim is justified and that all conditions of this warranty have been met, Nature's Comfort will repair or replace the problem part according to the above proration. Proof of purchase, treatment and testing and return of the defective part (if applicable) must be provided by the owner of the boiler before any warranty is given. All costs of removal, shipment to and from the dealer or Nature's Comfort and losses during shipment and reinstallation and any other losses due to the stove being removed shall be covered by the owner of the boiler. If your dealer no longer exists, please contact Nature's Comfort via email: warranty1@naturescomfortllc.com. If you do not have email you may call 877-251-7740.

This warranty is subject to change without notification. Please visit www.naturescomfortllc.com for the most up to date warranty and installation information.

Nature's Comfort LLC PO Box 949 Shipshewana, IN 46565

II. Best Outdoor Boiler Burn Practices

Read and follow all operating instructions.

- A. Fuel Used:** You may burn any seasoned hardwood. A well seasoned piece of wood will feel significantly lighter than one of the same type and size with higher moisture content. Higher moisture contents will result in reduced burn times as heat will be used up drying out the moisture for the wood to burn. Never burn driftwood, painted, stained or pressure treated wood. Do not burn trash, plastics, gasoline, rubber, naphtha, household garbage, material treated with petroleum products (particle board, railroad ties and pressure treated wood), leaves, paper products or cardboard.
- B. Loading Wood:** Keep wood covered and store outside of clearance area listed on page 4. For a more efficient burn, always add wood before the previous load has burned out. Most often the boiler can be loaded in the morning and at night. Burn times vary from 6-24 hours depending on fuel being used, installation, temperatures maintained and size of area being heated. Nature's Comfort makes no guarantees on burn times as there are too many variables outside of its control.
- C. Starting fire:** Do not use combustible fluids or chemicals. Use small pieces of split kindling together with crumbled newspaper and add larger pieces. Remember: The smaller the better, the dryer the better.
- D. Location:** It is recommended that the boiler be located with due consideration to the prevailing wind direction. The chimney is 6" steel and can be easily extended with standard 6" stovepipe. Install supports as directed by pipe manufacturer.
- 1 We recommend a distance of at least 100 feet be kept if prevailing winds blow towards any other residence not served by the boiler, it is recommended that the stack be at least 2 feet higher than the peak roof line of that residence.
 - 2 If located more than 100 feet but no more than 150 feet to any residence, it is recommended that the stack be at least 50% of the peak roof line of that residence, plus an additional 2 feet.
 - 3 If located more than 150 feet but no more than 200 feet to any residence, it is recommended that the stack be at least 25% of the height of the peak roof line of that residence, plus an additional 2 feet.

Chimney height relative to nearest downwind neighbor



Always remember to comply with all applicable state and local codes and laws.

E. Wood Recommendations

For maximum efficiency and burn times, you should only burn wood that has been seasoned for 12-24 months and sheltered from rain and snow. Burning unseasoned wood is wasteful and inefficient. Freshly cut, "green" wood uses much of the combustion energy to dry out the excess moisture. Ideally the wood should be split in 6-8" diameter pieces to aid in seasoning and should be around 20% moisture content by weight. Whole rounds burn well and are cheaper, but this type of wood also will have to be dried much longer, especially if in larger diameters.

The following are general guidelines for wood selection:

Keep wood open to the wind but covered as rain and snow will greatly hamper the seasoning.

Hardwoods burn longer than softwoods as they are denser and have more available BTU's.

Larger pieces burn longer than small pieces but take longer to season properly.

20% moisture content is optimum.

Wood with higher moisture content wastes energy to dry out wood.

Too low of moisture content (very dry, old wood) burns rapidly and inefficiently.

F. Heating the Home

The NCB boiler is designed to save energy and provide the most comfortable heating available. It heats your home by heating a firebox surrounded by a steel tank filled with water. The boiler is a non-pressurized boiler with an atmospheric vent. The hot water is then circulated through underground pex pipes to a water coil (heat exchanger) installed inside your existing central duct system. (Typical of most systems)

A typical water-to-air heat exchanger much like a small radiator or heater core in a car is installed in your ductwork. When air blows through it, heat is extracted and hot air blows out of your vents.



The Nature's Comfort outdoor boiler can also be connected to any existing radiant heating system that operates at 180 degrees or less using a plate heat exchanger. When connecting directly to an in-floor heating system, be sure to use a mixing valve to keep temperatures below the maximum rating of your system (usually 110F).

G. Heating Domestic Hot Water

To heat your domestic hot water, water from the outdoor boiler is circulated through a “water to water” heat exchanger which is connected to your existing hot water heater. This is either a plate or side-arm style heat exchanger. The hot water from the boiler usually goes to the exchanger at your hot water heater and then to the exchanger on your furnace. You may use either style exchanger with your hot water heater. If heating your home through a radiant system, first go through the exchanger for your old boiler system, then through the exchanger for your domestic hot water heater. Reverse this sequence for forced air systems. See page 19 for a layout of piping for a sidearm.

H. Thermostat, Boiler Controls

The only visible addition to the heating system inside your home is a second thermostat, which should be located near the existing thermostat. This second thermostat needs to be installed to operate your existing blower for forced air or your circulation pump for radiant heat and needs to be set higher than your original thermostat so your existing furnace will automatically take over to maintain your household temperature if your boiler is not running. Please see page 18 for an example wiring layout.

The outside boiler has a hot water thermostat (aquastat) with a thermocouple that is inserted into a brass drywell that senses the water temperature of the unit. When the temperature of water in the boiler falls below the “low” temperature setting on the aquastat, the solenoid lifts the cover off the blower which turns on, feeding oxygen to build a hotter fire and remains on until the water temperature in the boiler reaches the “high” temperature setting of the aquastat. Temperature may be set anywhere between 160 – 180 degrees F. Do not set above 180F. When heating your home through a radiant system, the recommended setting is 180. When heating with a forced air system, the recommended setting is 160. The aquastat also has a temperature swing setting that is adjustable from 5 – 30 degrees. The recommended setting is 15 degrees which provides for a longer burn cycle to burn off any creosote buildup.

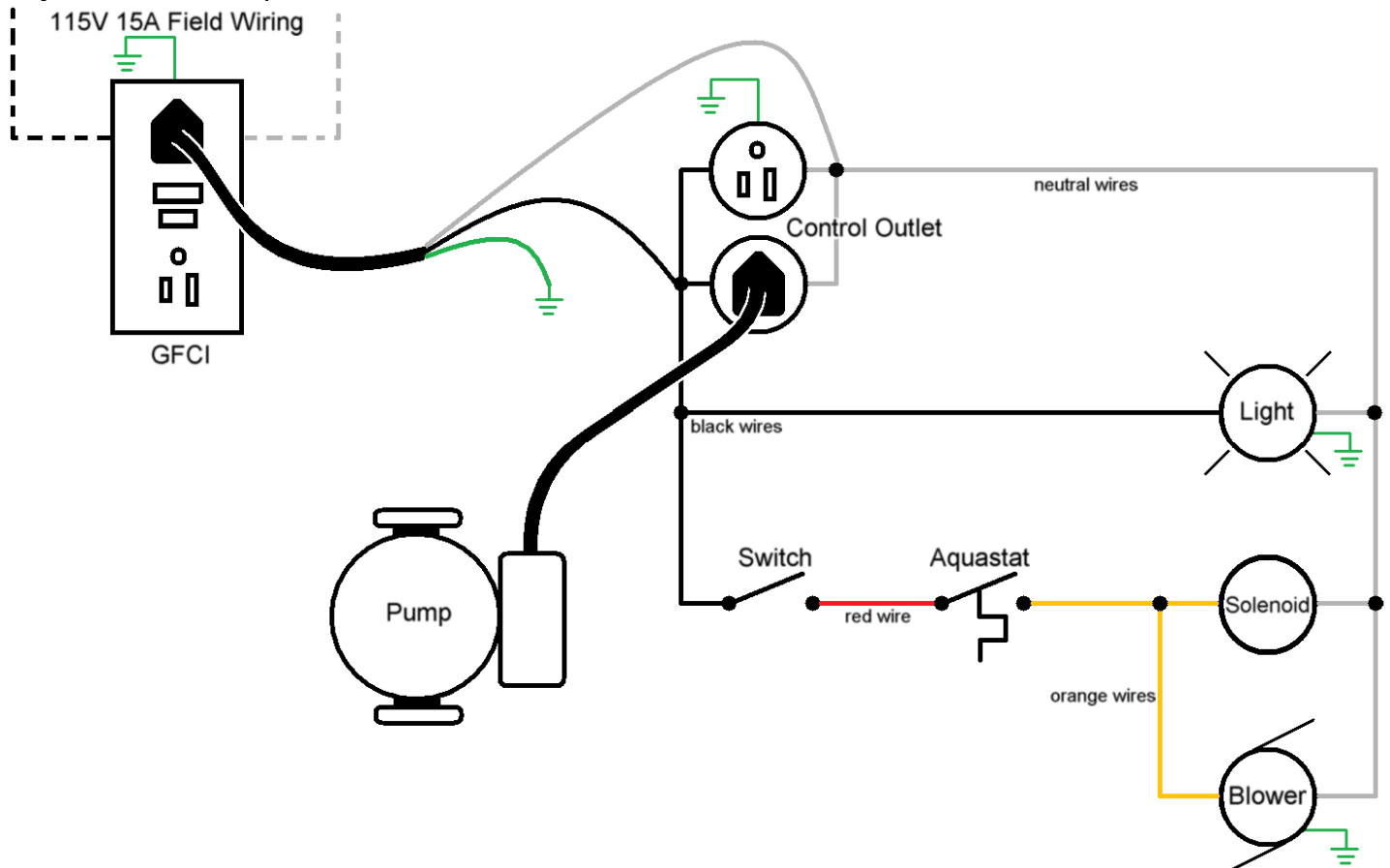

I. Controls & Pex Pipe Connections

Boiler shown is set up as a single-zone. You may install fittings to have ports for up to 4 ZONES (Consult your dealer. Additional port setups with pumps are also available from Nature's Comfort when ordering a new unit.)

Single-Zone setup

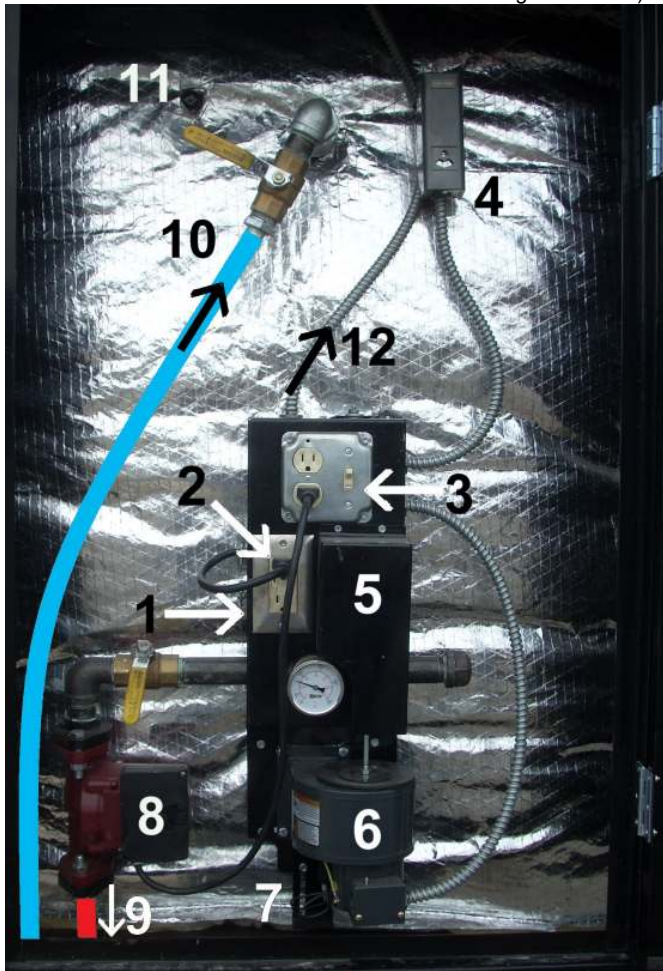

1. Power from home feeds GFCI
2. Control power for pump, aquastat, solenoid, blower and light is fed through main plug by GFCI.
3. Switch for shutting off power to aquastat (which will shut down blower & solenoid).
4. Aqua-stat sensor for controlling blower and solenoid.
5. Solenoid (behind cover) to lift intake cover off blower.
6. Blower to feed oxygen to fire.
7. Damper to control air flow.
8. Pump to circulate water. (One pump is included.)
9. Red Pex pipe goes from the pump to heat exchanger(s) in home. **Please note! The pump that came with your boiler may not be the correct size for your installation. Please consult your dealer for sizing as water flow is essential to the proper & efficient operation of your installation.**
10. Blue Pex pipe returns from home to upper port. (Use of additional valve is recommended for ease of servicing. Not included.)
11. Extra Port (This is for a low water cut-off switch if required by an inspector. Call your dealer to obtain if needed)
12. Wires to outdoor light.

J. Power Loss

The controls are also designed for the main control power plug to be used on a generator if needed. If there is a loss of power and the water jacket starts to overheat from lack of circulation first make sure to keep the water level full then use this feature if you have a generator to keep the pump running. This typically is only a problem in milder weather. The remaining outlets have a total of 10amps available to be used for additional pumps or convenience load if desired. Do not load more than this as overloading of the supplying circuit will occur.

K. Insulated Pex Pipe

We highly recommend the use of insulated pex pipe for the best heat transfer possible from the boiler to your home. 4" triple wrap, 5" five-wrap & 5" foam insulated pipe is available for purchase through Nature's Comfort or your dealer.

III. Installing Boiler

Boiler must be installed by a certified technician.

A. Location of Boiler

The outdoor boiler must be located to comply with the clearance requirements on page 4. Keep the door facing away from a structure so all fire danger is removed from your home. The boiler may be installed as much as 250 feet away using an appropriately sized pump and piping and still heat your house and hot water. However, if the boiler is located more than 100 feet away, you may experience inefficiency and heat loss. A larger pump than the one supplied may be needed for distances over 100 feet and/or any rise in elevation over 15 feet.

Locate the outdoor wood boiler where it will be convenient for refueling and wood storage. Pex pipe and power lines are to be installed underground between the house and the boiler and the pex must be buried below frost lines.

1. It is recommended that the boiler be installed with chimney extensions for due consideration to any neighboring residences and to the prevailing wind direction.
2. Do not locate the boiler within 100 ft of a residence not served by the boiler. Be considerate of neighboring residences, properties, parks, etc.
3. Do not locate the boiler near any combustible materials, gasoline or other flammable liquids or gases.
4. The boiler should be located away from dry, grassy areas and any buildings to minimize danger of fires.
5. Check with your insurance company and local codes or ordinances.
6. Do not install the boiler in an area where nearby structures or trees might cause down drafts.
7. Typically, outdoor wood burning boilers are located 40 to 100 ft down wind from the structure served.
8. To aid in smoke dispersal, extra chimney lengths may be required depending on the distance to surrounding structures. See page 8 for additional guidance.
9. The boiler requires a dedicated 15 amp, 115vac electrical service to operate.

Failure to keep the boiler area clear and free of combustible materials, gasoline and other flammable liquids and vapors can result in severe personal injury, death or substantial property damage.

B. Concrete Block Footing

A full concrete pad or footings just under the feet are not necessary for the installation for your boiler, but are recommended to prevent frost heaving. Four concrete footing blocks 8" X 16" X 4" will suffice if desired. You may add additional layers of blocks for ease of loading wood.

IMPORTANT! After installation, insulate the underside of the boiler with minimum 1" non-combustible hardboard insulation and install non-combustible type of skirting around the feet and control area to prevent wind from reducing efficiency.

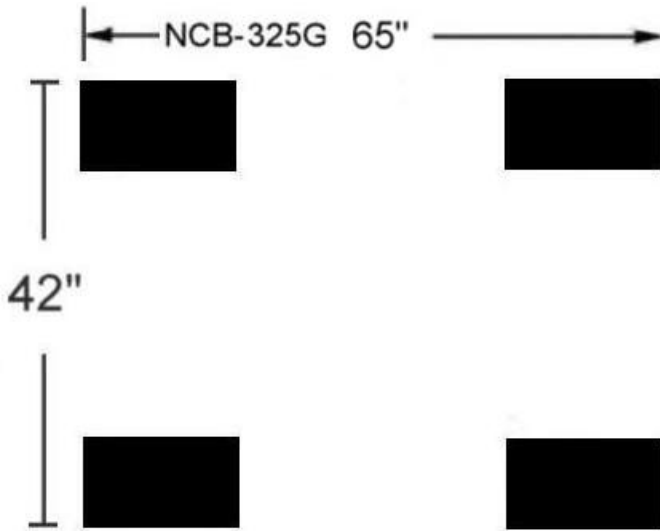

C. Plumbing Hook Up

1. Plumbing and electrical connections are made through the rear access door.
2. The water lines must be buried below the frost line to prevent freezing. The depth of the trench varies in different regions of the country. Be completely sure about the correct depth needed before the insulated pex pipe is installed underground. Contact your local building inspector's office for this information. **CALL YOUR LOCAL MISS DIG HOTLINE BEFORE YOU DIG TRENCHES!**
4. If you purchased insulated pipe, it may contain twine for pulling electrical wire. Do this before the pipe is in the trench for ease of pulling.
5. If more than one building is to be heated, additional pipe must be installed.
6. If you have rocky ground, make sure you place straw around the pipe before back filling, giving extra protection against punctures.
7. Keep 90's to a minimum as each one adds 1 foot of head pressure, reducing the rate of water flow.

HINT: If only one color of pipe is used, label the water lines or connect and test them before back filling over pipe and lines

L. Wiring the boiler

A qualified electrician must wire this boiler in accordance with the National Electrical Code.

A dedicated 15amp, 115vac circuit needs to be installed to power the GFCI. Land power & neutral wires to the back of the GFCI and wire nut the ground wire to the green wire that is fastened alongside the ground of the GFCI. See page 10 for a diagram. The size and type of electric wire to be installed depends on the distance from the boiler to the house. If the boiler is less than 100 feet from the house, #14 AWG UF cable is the smallest wire that may be used. If the distance is greater than 100 feet, #12 AWG UF cable must be used. A maximum of 5 amps is used by the boiler if all standard equipment is running and dual 100watt light bulbs are used. The extra outlets will provide a total of 10amps for convenience use.

E. Installation of Pex Pipe

Keep the pex pipe underground as it enters the house. Make sure to seal around the pipe to prevent water from entering structure. This can be done with a can of expanding foam. If conditions require the pipe to be above ground for entering the home, make sure to insulate thoroughly.

CALL YOUR LOCAL MISS DIG HOTLINE BEFORE YOU DIG TRENCHES!

F. Filling Boiler with Water

Do not start circulation pump until it has been primed! Loosen the top screw on the pump until a steady stream of water flows and all air has been purged. Being a wet-rotor unit, if the pump runs dry at all, it will seize up as the bearings rely on lubrication from the water. Once all piping connections are complete, pour the Nature's Comfort boiler treatment in, fill the boiler with a hose through the float stack or if you have installed a fill line, open the valve and allow it to fill until the float starts to rise. Use water that is softened or has low iron content if possible. During the first heating cycle the water might expand and overflow. This is normal and will occur anytime too much water has been added. After priming and starting the circulation pump and bleeding the heat exchanger let your boiler heat up and run for 24 hours then top off the water again. The ideal water level is at the end of a heating cycle for the level indicator to be at the top of the rubber cap. The water level will rise and fall during operation as water expands and contracts with temperature changes. Be sure to keep your boiler within 3" of being full at all times including through the summer as this will keep your boiler free from corrosion and when in use, from overheating causing circulation pump failure.

G. Plumbing Parts Needed

1. A 1" pex crimp x 1" NPT is needed to install the outgoing pex line into the flange that is supplied and already mounted to the lower end of the circulation pump. The flange is a female 1" NPT. The return line must be installed in the opposite lower corner for cross flow of the water jacket so no hot spots are created on the firebox.
2. Extra pex fittings can be purchased from your local hardware or plumber.

The pex pipe connected to the bottom of the pump runs to the house and normally runs to the heat exchanger installed in your furnace or a plate heat exchanger for a hydronic radiant system. See page 20 for more information on hooking up a brazed-plate heat exchanger.

3. The pump comes already mounted directly to the boiler with a shut-off valve. If the pump ever has to be changed, the water supply can be shut off so for easy replacement. It is highly recommended that you purchase a 2nd pump as a spare for if your pump should ever fail as your boiler cannot function without it. This will prevent downtime, loss of heat to your home and overheating of your boiler. **Please note! The pump that came with your boiler may not be the correct size for your installation. Please consult your dealer for sizing as water flow is essential to the proper & efficient operation of your installation.**

Add a valve to the return line at the boiler so if repair or service is needed on lines or equipment, the water in the boiler can be isolated without having to be drained.

Note: For larger homes, 1- $\frac{1}{4}$ " pipe may be needed for maximum BTU output. A 1- $\frac{1}{4}$ " pipe can carry up to 37% more BTUs due to higher water flow. The fittings above would need to be changed to accommodate 1- $\frac{1}{4}$ " Pex. The Armstrong E9 pump available from Nature's Comfort has the ability to do this in a 1" pipe within distance & height limitations.

H. Adding Bypass Valves

Adding a bypass valve system at each heat exchanger is a good idea so that if there is a potential problem such as a stopped up heat exchanger, it can be diagnosed & serviced easily by the owner as well as being used for a summer bypass as explained on page 19 (Figure shows 3-valve setup used for bypass and isolation).

I. Installing the Heat Exchanger in the Plenum

Note: It is recommended that you contact your local plumbing/heating contractor to supply and install the heat exchanger unless you have the tools and experience required.

The heat exchanger must be installed below the evaporator coil if you have air conditioning. This is required since the heat exchanger may freeze and crack when the air conditioner is used. If it is not possible to place the heat exchanger between the furnace and the evaporator coil, you must drain the heat exchanger before using the air conditioner. It is recommended that a bypass system of valves be installed for servicing and draining the heat exchanger if necessary. (Noted above)

The heat exchanger must be installed so that it is airtight. No air must be able to flow around it or out of the ductwork. Use adhesive backed foam tape (used for insulating doors and windows) around the water coil. Use foil tape to seal off the heat exchanger and the hole you make.

Make sure the fittings for the supply and return lines are easy to get to once the heat exchanger is installed.

You should be able to find a heat exchanger to fit most popular sizes of plenums. If you are unable to your ductwork must be modified to accept the heat exchanger. This is best left to a professional unless your ductwork is made up of fiberboard. In all cases wear proper protective gear. (gloves, safety glasses, etc...)

Measure the width of the heat exchanger (Dimension A in next diagram). Measure the thickness of the heat exchanger (Dimension C).

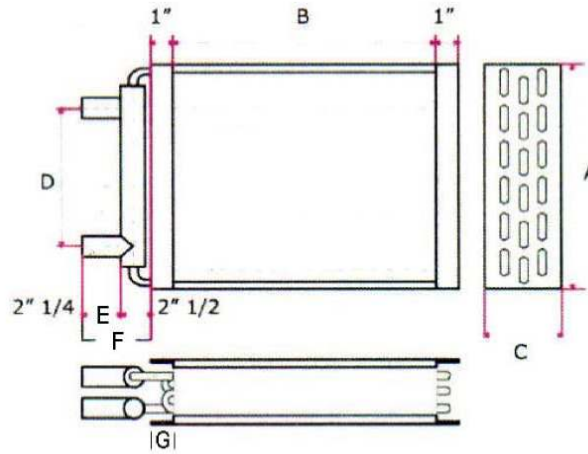

Start by cutting a hole in the side of your ductwork the thickness of the heat exchanger (Dimension C) and the full length of the ductwork (usually Dimension A).

WARNING! Metal edges are very sharp! Wear protective gloves and use caution!

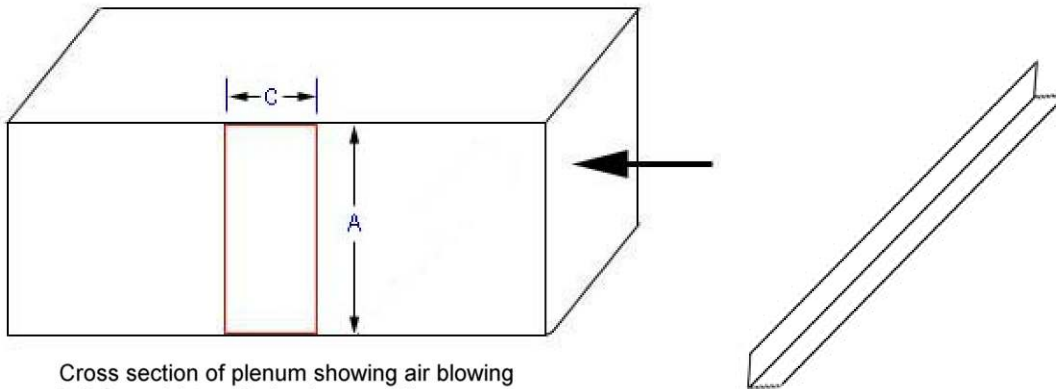

Cross section of plenum showing air blowing in it from right cut hole where red lines are.

Slide the heat exchanger into the hole for a test fit. Ideally the tubes (D and E) should stick out of the plenum (see diagram above). The header and tubes (F) can stick out of the plenum as well, if necessary. As long as the entire coil surface (B) is in the plenum, operation should be fine even if the header (F and G) sticks out.

While test fitting try to determine how much tape is needed around the frame of the heat exchanger to seal and keep air from flowing around it. A different amount (thickness) may be needed on different sides. You can purchase different thicknesses of tape so that it will fit and seal properly. Use enough foam tape so that it fits tight and air can't blow by it.

The heat exchanger needs to be installed so it won't move up or downstream in the plenum. The easiest way is to fabricate some pieces of metal into an L' shape, approx. the length of the heat exchanger like shown above.

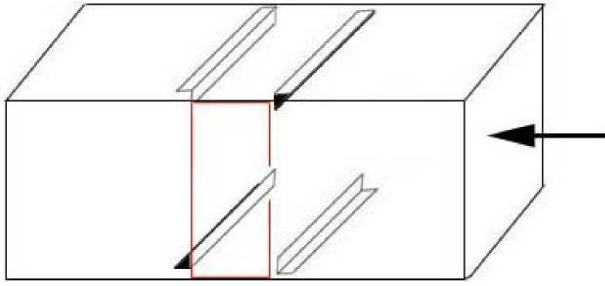

Install the braces the proper width apart as shown above (Dimension C). Secure them in place using pop rivets or self tapping screws. You will need four pieces, two on the top and bottom.

Slide the heat exchanger carefully into the plenum to check the fit again. Once proper fitting is verified, you can seal off the ends of the heat exchanger and the hole you made in the plenum with foil tape made for ductwork.

J. Installing a Heat Exchanger in a Small Plenum

You can install a heat exchanger in a plenum that is smaller than the length of the heat exchanger, as follows. Make cuts at the top and bottom of the plenum, usually 4 inches long (the width of the heat exchanger) as shown below. You may need to do this on both sides of your ductwork depending on your heat exchanger size.

Cut another line vertically, between the other two cuts, right in the middle as shown.

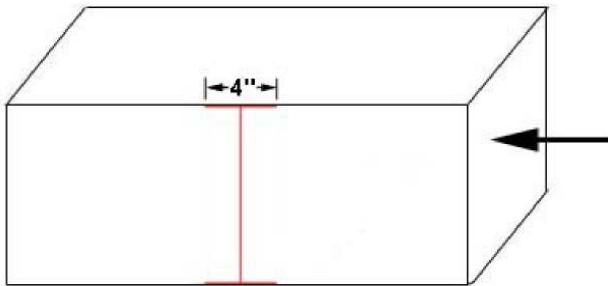

Cross section of plenum showing air blowing in it from right
Cut hole where red lines are

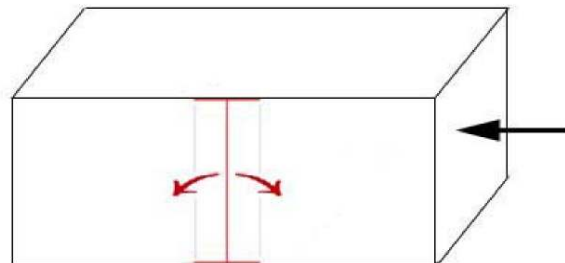

Bend the sheet metal back and out, along the grey lines.
Repeat on the back side of the plenum, in the same spot.

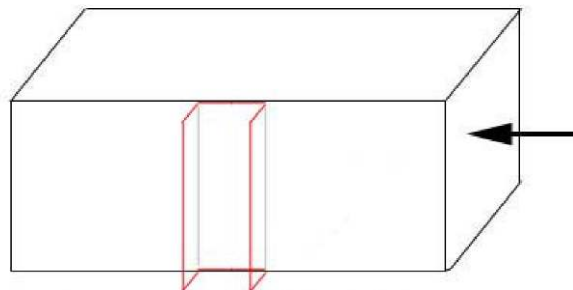

Bend the metal pieces back to slightly past 90 degrees.

Slide the heat exchanger through the front hole to the back hole so it protrudes out the front and back of the plenum.

Ideally the core of the heat exchanger will be entirely within the plenum.

Crimp the sheet metal to the edge of the heat exchanger. This is item G in the diagram on page 16 using channel-lock pliers to crimp.

This not only forms a virtually airtight seal, but it also supports the heat exchanger as well.

K. Bleeding the Heat Exchanger

With the pump running (Prime first and turn the thermostat up so that the pump comes on), simply close the brass valve on the return side, holding for 2-3 seconds, then open quickly. Repeat the procedure four times or until you cannot hear air rushing through the line.

L. Air Flow through Plenum

The motors on most force air furnaces have three speeds to provide various rates of air movement. Please consult a local furnace specialist if you want to change the airflow of your existing furnace system.

M. Thermostat Wiring Layout

This setup is for controlling your furnace blower independently of your existing heat source.

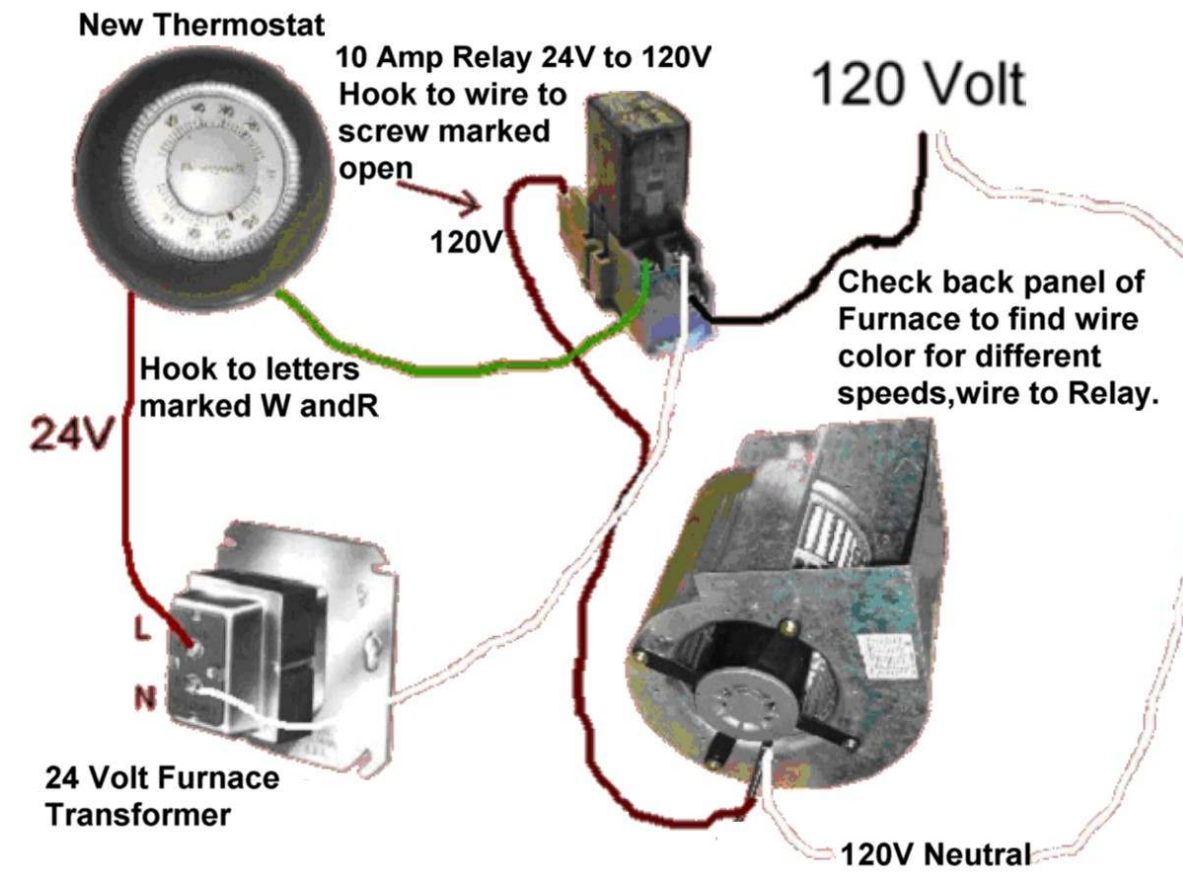

IV. Other Hook Ups - Heating Domestic Water, Pools and Spa's

A. Layout of Water Lines for Sidearm

The hot line from boiler goes into the top of sidearm. This creates twice the domestic water flow through the sidearm as opposed to coming in at the bottom. Hookups to the domestic side must be connected to drain and pressure relief ports. Make sure to keep drain & pressure relief in service & purge all air from piping and sidearm. **Use a mixing valve to control water temperature.**

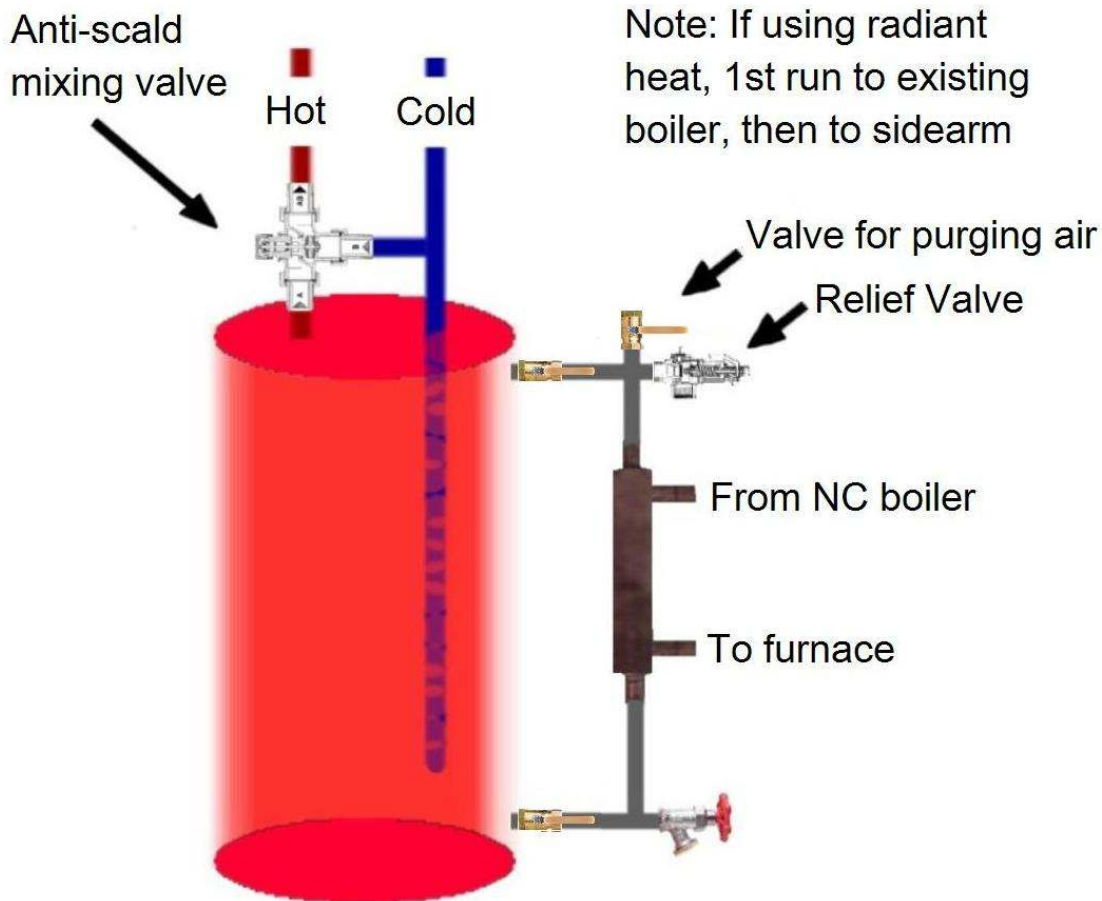

B. Warm Weather Operation and Hot Water Bypass

Operation in warmer weather will result in larger amounts of creosote and will be tricky as too many coals will cause the water jacket to boil if not enough heat is being used. To compensate, load less wood and/or purchase a chimney damper to reduce draft through the chimney. (Call Nature's Comfort for where to find) Adequate water circulation is critical for preventing water from boiling (see page 11). Make sure all gaskets and air intakes are properly sealed to prevent any extra air from feeding a fire. See the maintenance section for how to adjust the main door seal.

For heating of domestic hot water without heating your home, install a 3-valve bypass system shown below. This permits you to use your boiler during the spring, summer and fall seasons to heat your hot water when you may not need or want to heat your house. The bypass permits the water to run from your boiler to the hot water heater and bypass the heat exchanger in the furnace plenum. Use of union fittings between the isolation valves and heat exchanger for easy removal is recommended as the plenum heat exchanger must be drained or removed so the water doesn't freeze when running air conditioning.

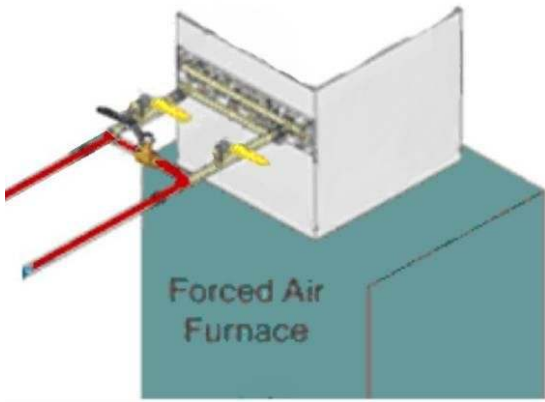

C. Heating a Pool or Spa

Please contact your local pool/spa contractor if this boiler is to be used to heat a pool or spa. You must consult with a pool/spa specialist since the chemicals used in a pool/spa are destructive to your boiler. A stainless steel (or 90/10 copper/nickel alloy) tube & shell water-to-water heat exchanger must be used to transfer heat from the boiler to a pool or spa. Pool heat exchangers are available from Nature’s Comfort. For sizing you will need to know the volume of the pool in cubic feet or gallons. Be sure to install isolation and bypass valves for easy servicing and also place before a chlorinator.

D. Connecting the Boiler to an Existing Indoor Boiler

A heat exchanger is needed to transfer heat from the outdoor boiler to another indoor boiler or hydronic system so that the two systems remain isolated from each other.

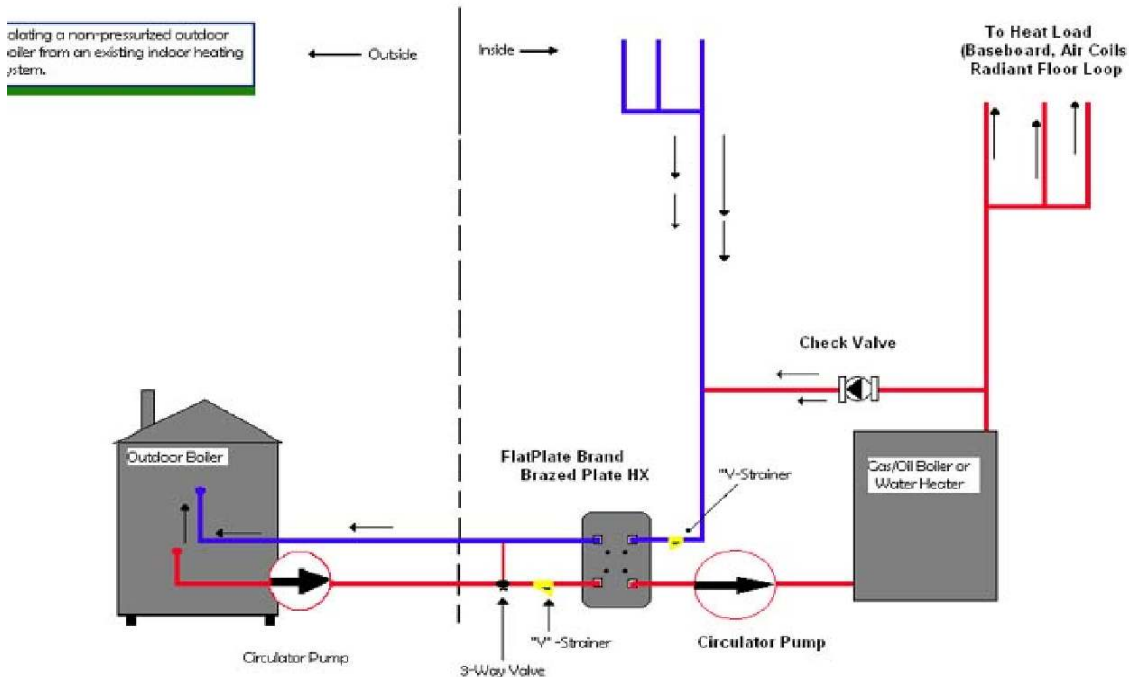

As shown in the above figure, the two systems are totally isolated from each other so that the existing hydronic system remains undisturbed and functions exactly as it did before. All pumps and controls remain essentially the same on the existing system. If a 30-plate unit or larger is used, a larger circulation pump on your boiler is recommended for proper water flow.

Water that circulates through the boiler is never circulated through the home’s hydronic system or vice-versa.

V. Maintenance

A. Cleaning Out Ash

Moisture combined with ash will eat through a boiler in short order and ash corrosion is NOT covered under warranty.

With our firebrick grate and ash pan, ashes can be removed while the fire is still burning. Clean ashes out frequently to prevent damage from corrosion. Make sure to turn off power to the blower before removing ash pan and wear heavy gloves and safety glasses as ash pan will be hot. Put back in place quickly once empty as free-flowing air will cause fire to burn too hot.

B. Creosote - Formation and Need for Removal

1. When wood is burned slowly (smoldering) it produces tar and other organic vapors which combine with expelled moisture to form creosote. This occurs on a larger scale when there is too much moisture content in the wood being used or during milder weather. The creosote vapors condense in the cooler chimney flue of a slow-burning fire. As a result, creosote residue accumulates on the flue lining. Smaller intense fires, shorter idle times & dry, seasoned wood will help limit this. When ignited, this creosote makes an extremely hot fire. If a chimney fire occurs, shut down the blower. Do not spray water to keep the steel cool as this will damage the boiler, simply keep the water jacket full.
2. The chimney and any connectors must be inspected frequently (at least twice a month) during the heating season to determine if a creosote buildup has occurred. If creosote has accumulated it should be removed to reduce the risk of a chimney fire.
3. All creosote and ash must be cleaned from the firebox frequently as ash mixed with moisture is very corrosive and will shorten the life of your boiler if not maintained properly. Check daily until experience shows how often cleaning is necessary.

C. Door Seals

Check rope seals on the loading door and ash pan periodically during the heating season as they will compress. Loosen the bolts on the hinge and/or latch to re-position the main door for tightening the seal if necessary. If the latch has no remaining adjustment, add washers behind the door handle to further tighten the latch side. If there is no more adjustment available and the door is not sealing properly, the rope seal must be removed, cleaned & loosened up, reversed and re-installed or replaced with new rope. For installation, re-position the door hinge and latch as far out as possible and install the rope seal with a liberal amount of high temperature caulk behind it for maximum adjustment. Make sure to push the rope to the outside of the corners to mate properly with the jamb (do not stretch the rope). Close the door once to custom fit the seal to the jamb, then leave door open until caulk behind rope is fully cured (ensure there are no raised portions that will leave gaps!). Re-adjust door to properly seal. Contact your dealer or Nature's Comfort for new rope or caulk if needed. This is a normal maintenance item and not a warranty issue.

D. End of Season

1. **Power:** Turn off power supply at the appropriate circuit breaker
2. **Chimney:** Inspect & Clean. Cap the chimney to keep rain water out.
3. **Firebox & Ash Tray:** Remove ashes, soot, and hardened deposits from the fire chamber by using a putty knife and/or wire brush. Coat the inside of firebox with a light coat of motor oil or WD-40 to protect the steel during the off-season.
4. **Doors:** Oil door hinges and latch.
5. **Plumbing:** Ensure fittings on both ends of tubing are tight at all locations.
6. **Water Treatment** Unless you are using anti-freeze or glycol, make sure your water is tested and has enough Nature's Comfort water treatment so there will be no rust or corrosion. See warranty for further details.

Moisture from rain or condensation must not be allowed to accumulate in the firebox or ash pan during the off-season. Failure to perform preventive maintenance may result in severe corrosion and major damage to the boiler. This is NOT covered under warranty.

VI. Trouble Shooting

Problem	Cause	Solution
Boiler does not come up to temperature.	Green or soft wood is being used, Wind blowing under boiler	Use dry, hard wood Take one or two inches of hard board insulation and place under boiler between legs then add non-combustible spacers between ground to hold up insulation
The boiler is at temperature and is steaming	Poor water circulation (excess fittings, too small of pipe, improper installation)	Change to a larger pump, use sweeping bends instead of 90's
Poor burn time	Green or soft wood is being used, Damper is open too far, too much demand on unit	Use dry, seasoned hard wood Adjust damper to highest position, lower temperature set points
Boiler is up to temperature but little to no heat in house	Poor circulation (A simple test can be done to determine if this is so: touch the pex line leaving and returning to boiler. There should be little or no temperature difference) Heat exchanger plugged Improperly designed installation Not enough insulation in building	Change to a larger pump Clean and add a y-strainer – be sure to use treatment! Reduce number of 90's & T's used Add insulation to structure
Boiler over heats	Air leak Damper open to far Poor circulation Water is low in boiler Aqua-stat malfunction	Make sure loading door is sealed & adjust if necessary, make sure ash pan is shut Adjust damper to highest point Larger pump, reduce # of fittings Add water to keep full Replace Aqua-stat
Boiler fire does not stay lit	Not leaving some coals in burn area No air flow	Leave some coals in burn area Check the area behind the ash pan to make sure there is no ash build up that would block blower air way, replace blower
Good wood but does not burn. Only smolders	Blower air way plugged	clean air way
Boiler up to temperature but no heat in house	Circulation pump failed	Remove screw on top of pump to see if shaft is spinning. If not turn power off & turn shaft with screw driver until loose. Turn power on & check to see if shaft is spinning. If not, replace pump. Pump has a one year warranty and must be returned to dealer for replacement
Boiler water getting rusty	Not enough or no boiler treatment	Have your dealer or Nature's Comfort test your water. Boiler treatment is required for warranty to be valid! See warranty.
Solenoid opens damper but blower won't come on	Blower burned out	Replace blower
Blower turns on but solenoid does not open	Loose electrical connection Solenoid burned out	Turn power off and check all wire connections Replace solenoid
Water leaking from boiler	Condensation from first start-up of boiler Condensation from wet wood	Wait for water to come up to temperature

VII. Disclaimer

All installation and operation must follow Federal, Provincial, State and Local codes, ordinances and laws.

Nature's Comfort boilers are not intended to be used in urban areas.

Nature's Comfort boilers are not intended to be the only source of heat. A backup system should always be in place and ready for use.

Nature's Comfort boilers are not intended to and must not operate under pressure.

All electrical and plumbing should be done by qualified personnel and conform to national, state and local electrical, plumbing, fire and building codes.

Manufacturer is not liable for damages to personnel or property for misuse, improper installation of equipment or for knowing Federal, Provincial, State and Local codes, ordinances and laws including local installation codes.

Owner assumes all responsibility for this.

GOING AWAY

When going away during freezing weather and no one will be keeping the boiler going, turn your backup heat system on, the boiler blower switch off and keep the circulation pump running. Your boiler will now operate in reverse being kept above freezing by your backup system eliminating the need to otherwise drain the boiler.

Please keep this manual with all other important papers. The information in this manual is necessary for the installation, operation and proper use of your boiler. If you should ever have a problem or question refer to this manual or call your dealer. Please have your serial number ready. This is found on a label on the back of the rear access door or stamped into the fire door jamb on the top left. If your dealer does not have the information you need, request they contact Nature's Comfort and your dealer will be further educated to provide the best possible customer service. If you are unable to get service from or reach your dealer you may contact Nature's Comfort via email: warranty1@narescomfortllc.com. If you do not have email you may call 877-251-7740. Please keep in mind that Nature's Comfort built your boiler but did not install it and has no control over the installation, the efficiency of the building's insulation or what is burned in the boiler.

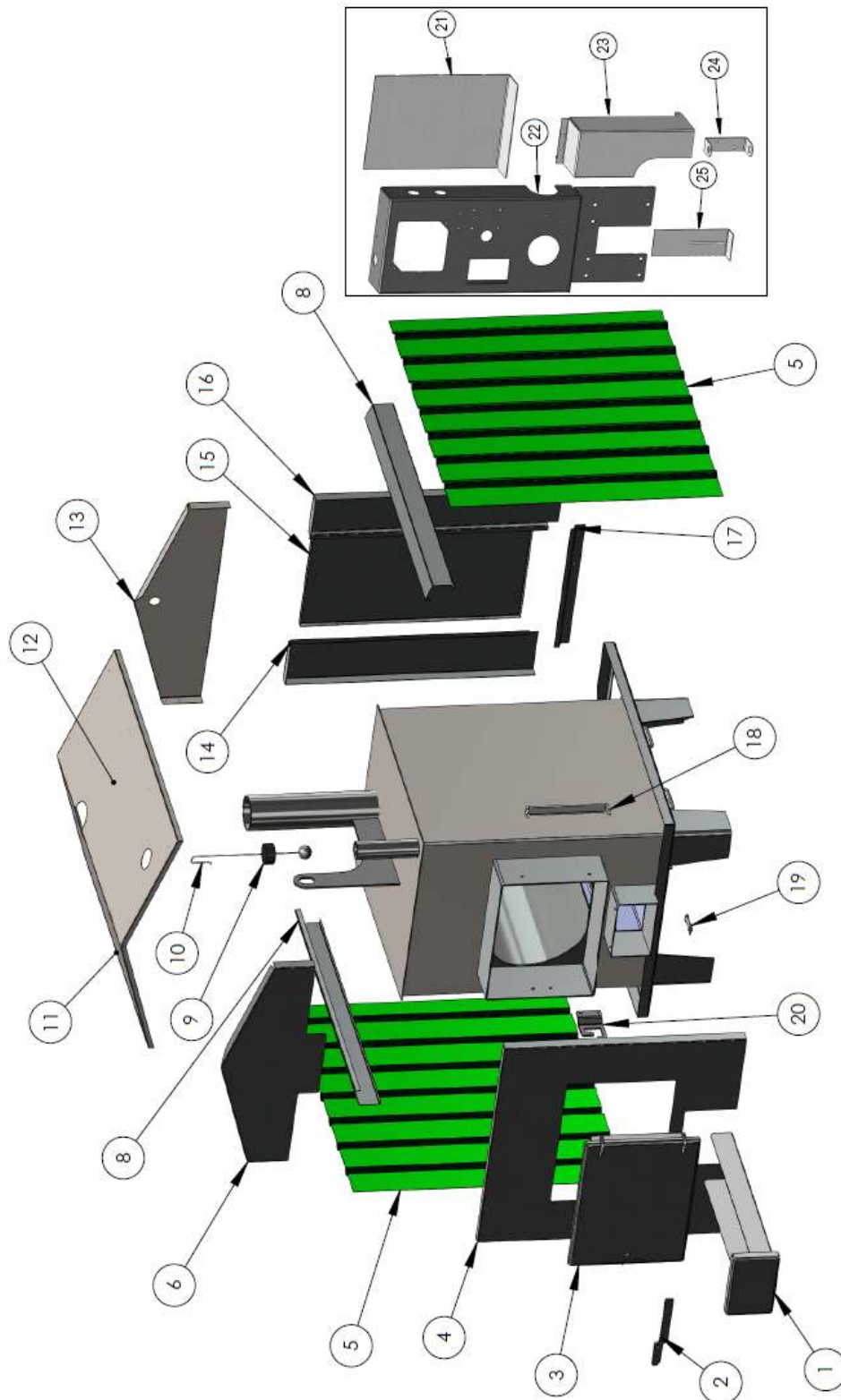

1	Ash Pan	13	Rear Gable Skin	25	Blower Damper
2	Firebox Door Handle	14	Right Control Frame		
3	Firebox Door	15	Control Access Door		Components on Page 11
4	Front Skin	16	Left Control Frame		GFCI
5	Side Skin	17	Lower Control Jamb		Outlet
6	Front Gable Skin	18	Firebox Door Hinge		Switch
7		19	Ash Pan Latch		Aquastat
8	Upper Side Frame	20	Firebox Door Latch		Solenoid
9	Rubber Cap	21	Control Panel Rear Cover		Blower
10	Stainless Steel Level Float	22	Control Panel Front		Circulation Pump
11	Left Roof Panel	23	Solenoid Cover		Outdoor Light
12	Right Roof Panel	24	Blower Intake Cover Guide Bracket		Temperature Gauge

VIII Warranty Registration Card (To be mailed in)

All fields must be filled out

Your Name: _____
(First) (Middle) (Last)

Address: _____
(Street)
_____ (City) (State) (Zip)

Phone Number: _____
(Area code) (Number)

E-mail Address: _____
(For contact purposes only)

Serial Number: _____

Date of Purchase: _____

Dealer Purchased From: _____

Date of Installation: _____

Installed By: _____

Installer's Address: _____
(Street)
_____ (City) (State) (Zip)

Installer's Phone Number: _____
(Area code) (Number)

Mail to: Nature's Comfort LLC
PO Box 949
Shipshewana, IN 46565



Certification Statement From Nature's Comfort, LLC

The NCB-325G Outdoor Wood/Coal Updraft Gasification Boiler is confirmed and certified by Nature's Comfort, LLC, PO Box 949 Shipshewana IN 46565 to be an outdoor hydronic heater that uses the burning of biomass fuel to heat a dwelling unit or to heat water for use in such a dwelling unit, and has a thermal efficiency rating of at least 75 percent as measured using a lower heating value and therefore complies to the standards required by the Energy Improvement and Extension Act (EIEA) of 2008 to be identified as "qualified energy property" and thus eligible for tax credits under the American Recovery and Reinvestment Act of 2009.

"Under penalties of perjury, I declare that I have examined this certification statement, and to the best of my knowledge and belief, the facts are true, correct and complete."

James Van Harn II, Business Administrator

NCB-325G Owner's Information

The NCB-325G Outdoor Wood/Coal Updraft Gasification Boiler below has been installed at the following address, which is the current principal dwelling of the named taxpayer:

Name: _____

Address: _____

City: _____ State: _____ Zip: _____

Serial # _____

Date Installed _____

It is not required to present this certificate with your tax returns, but this certificate must be kept with your tax records. A professional tax consultant should be contacted for questions by taxpayers claiming a tax credit. **DISCLAIMER:** Nature's Comfort, LLC does not hold itself responsible or liable for a taxpayer's ability to receive a tax credit. Nature's Comfort, LLC is not a tax advisor.